

M12 male 0° / M12 female 90° shielded

PUR 4x2x0.25 shielded gy 35m

shielded

Art-No. 7005 - M12 Lite - (plastic hexagonal screw) on request

Male straight – female 90°

M12 – M12, 8-pole

Plastic housings with good resistance against chemicals and oils.

The resistance to aggressive media should be individually tested for your application. Further details on request.

Further cable lengths on request.

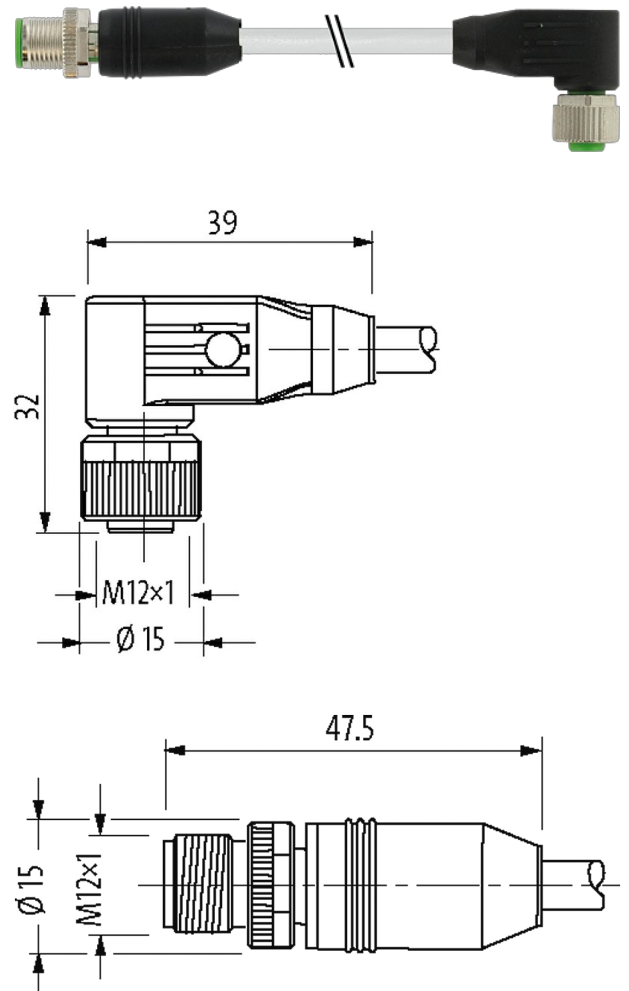
[Link to Product](#)**Illustration**

Product may differ from Image

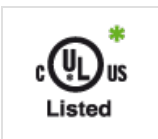
Approvals

* only for products with UL/CSA approved cable

Form

Form 48051

General data	
Pollution Degree	3
Temperature range	-25...+85 °C, depending on cable quality
Standards	DIN EN 61076-2-101 (M12)
Cables	
Cable number	286
No./diameter of wires	4 × 2 × 0.25 mm ²
Wire isolation	PP (wh, br, gn, ye, gr, pk, bl, rd)
Jacket Color	gray
Material (jacket)	TPU
Outer Ø	7.1 mm ±5%
Bend radius (moving)	15 × outer Ø
Temperature range (fixed)	-40...+90 °C
Temperature range (mobile)	-5...+90 °C
Cable identification	286
Approval (cable)	CE conform
Cable weight [g/m]	74,80
Material (wire)	Cu wire, bare
Resistor (core)	max. 79 Ω/km (20 °C)
Single wire Ø (core)	0.1 mm
Construction (core)	32 × 0.1 mm (multi-strand wire class 6)
Diameter (core)	4 × 2 × 0.25 mm ²
AWG	similar to AWG 24
Material (wire isolation)	PP
Material property (wire isolation)	CFC-, halogen-, cadmium-, silicone- and lead-free
Shore hardness (wire isolation)	65 ±5 D
Wire-Ø incl. isolation	1.2 mm ±5%
Color/numbering of wires	br, wh, rd, bl, pk, gr, ye, gn
Shield	yes
Material (jacket)	TPU
Shore hardness (jacket)	85 ±5 A
Outer-Ø (jacket)	7.1 mm ±5%
Color (jacket)	gray
chemical resistance	good resistance to oil, gasoline and chemicals (EN 60811-404)
thermal resistance	flame retardant EN 60332-1
Nominal voltage	300 V AC
Test voltage	1500 V AC
Current load capacity	to DIN VDE 0298-4
Temperature range (fixed)	-40...+90 °C
Temperature range (mobile)	-5...+90 °C
Bend radius (fixed)	7.5 × outer Ø
Bend radius (moving)	15 × outer Ø
Technical Data	
Operating voltage	max. 30 V AC/DC
Operating voltage (only UL listed)	max. 30 V AC/DC
Operating current per contact	max. 2 A
Material group	IEC 60664-1, category I

Coding	A-coded
Locking of ports	Screw thread (M12×1 mm) recommended torque 0.6 Nm, self-securing
Compression gland	M12 (SW13)
Protection	IP66K, IP67 inserted and tightened (EN 60529)
Locking material	Zinc die casting, nickel-plated
Material	PUR
Rated surge voltage	0.8 kV

Commercial data

country of origin	CZ
customs tariff number	85444290
EAN	4048879564069
eClass	27279218
Packaging unit	1

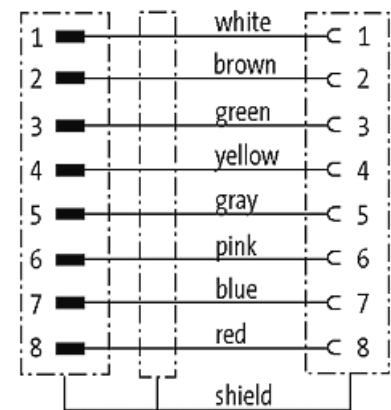
Sketch

Male

Female

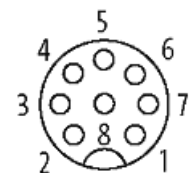
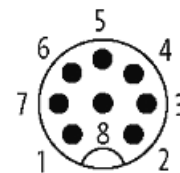

Product may differ from Image